









INDEX	CHANGES	DATE	NAME

-  MEGA-DEEP-DRILL-ALU
-  30° HELICAL FLUTE
-  CUT MAT HU680
-  MAT SEE CATALOG
-  WITH I.C.
- 
- 

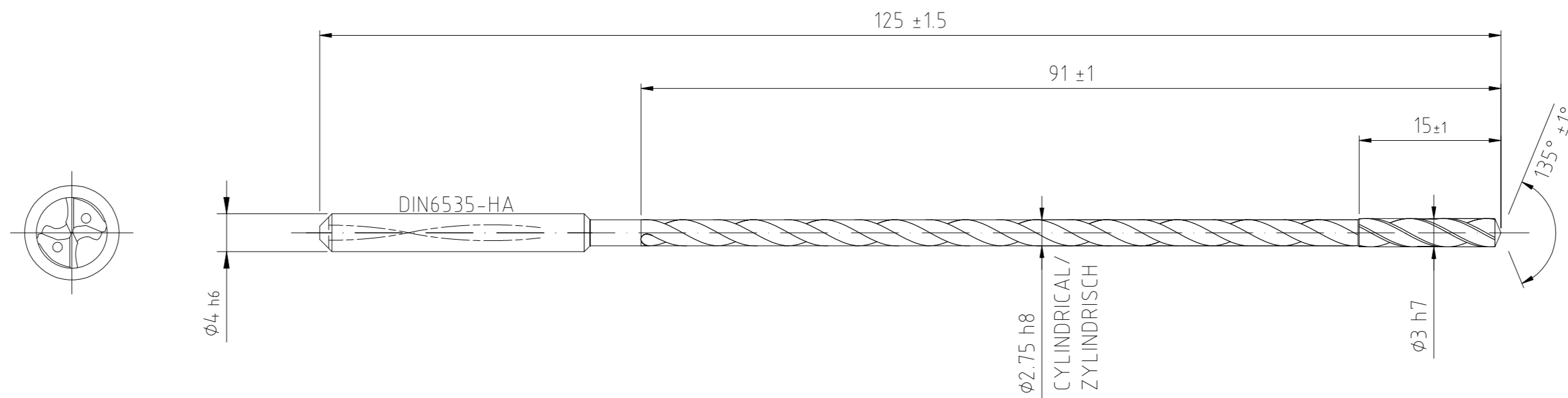

COMPONENT			MAPAL © FABRIK FUER PRAEZISIONSWERKZEUGE DR. KRESS KG			TITLE			MEGA-ALU-DEEP-DRILL, SHANK FORM HAK, UNCOATED			FORMAT	
PART FEATURE			ALL RIGHTS FOR THE INVENTIONS, KNOW-HOW, TECHNICAL SOLUTIONS AND DESIGNS SHOWN ON THE DRAWING ARE ENTITLED TO MAPAL ONLY. AS FAR AS MAPAL DID NOT REGISTER PROPERTY RIGHTS HEREUPON YET, MAPAL FORMALLY RESERVES THE RIGHT FOR THE REGISTRATION OF PROPERTY RIGHTS. THE DRAWING AS WELL AS THE MATTERS SHOWN ARE STRICTLY CONFIDENTIAL. REPRODUCTIONS MAY ONLY BE MADE FOR THE PURPOSE AGREED UPON. NEITHER THIS DRAWING NOR COPIES THEREOF MAY BE MADE ACCESSIBLE TO THIRD PARTIES. WITH THE DELIVERY OF THIS DRAWING NO RIGHT TO USE IT FOR ANY PURPOSE IS GRANTED. VIOLATIONS AGAINST THE OBLIGATIONS TO SECRECY AND USE RESTRICTIONS WILL BE PROSECUTED.				MAPAL Präzisionswerkzeuge Dr. Kress KG	DATE OF ISSUE	CREATED	DOCUMENT			INDEX
CUSTOMER COMPONENT REFERENCE								2022-07-07	SKO	607739423-000-00-ED1			00
WORKPIECE MATERIAL			TOOL-NO.	OP-NO.	GENERAL TOLERANCE ISO 2768-mH SIZE ISO 14405-1	DIMENSIONS NOT SHOWN ARE MAPAL STANDARDS		SCALE	TECHNICAL SPECIFICATION			SHEET	
SEE CATALOG									2:1			SCD181-0300-2-4-135HA25-HU680	