









-  MEGA-DRILL-STEEL-PLUS
-  30° HELICAL
-  CUT MAT HP358
-  WITHOUT I.C.
- 
- 

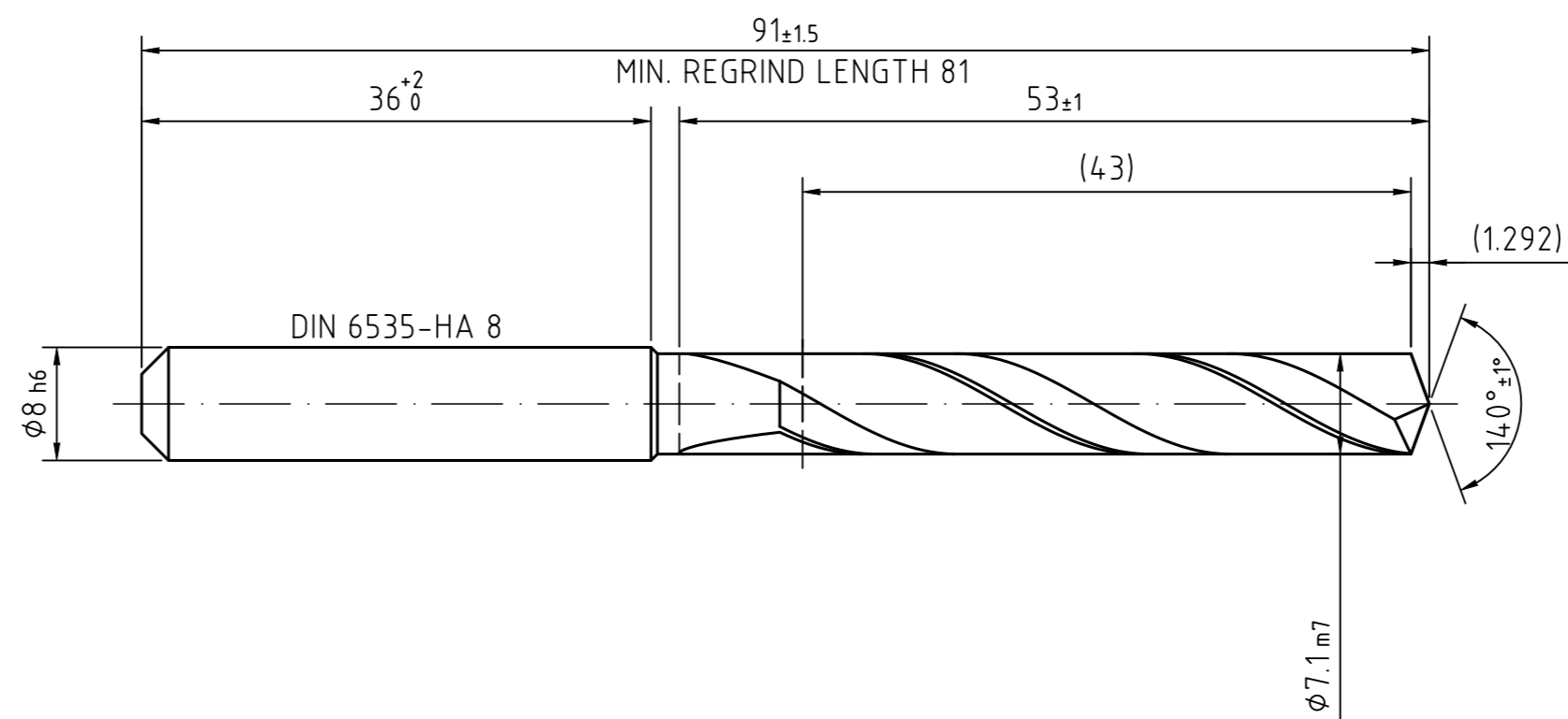
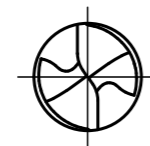

INDEX	CHANGES	DATE	NAME

NON TOLERANCED DIMENSIONS				
0.5	> 3	> 6	> 30	> 120
... 3	... 6	... 30	... 120	... 400
± 0.1	± 0.1	± 0.2	± 0.3	± 0.5
± 0.2	± 0.5	± 1	± 1	± 1
RADII, CHAMFERS				
± 0.2	± 0.5	± 1	± 1	± 1
ANGLES, DIM. OF THE SHORTER SIDE				
bis 10	> 10	> 50	> 120	> 400
... 50	... 120	... 400		
± 1°	± 30'	± 20'	± 10'	± 5'

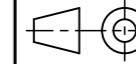
MAPAL © FABRIK FUER PRAEZISIONSWERKZEUGE DR. KRESS KG <small>ALL RIGHTS FOR THE INVENTIONS, KNOW-HOW, TECHNICAL SOLUTIONS AND DESIGNS SHOWN ON THE DRAWING ARE ENTITLED TO MAPAL ONLY. AS FAR AS MAPAL DID NOT REGISTER PROPERTY RIGHTS HEREUPON YET, MAPAL FORMALLY RESERVES THE RIGHT FOR THE REGISTRATION OF PROPERTY RIGHTS. THE DRAWING AS WELL AS THE MATTERS SHOWN ARE STRICTLY CONFIDENTIAL. REPRODUCTIONS MAY ONLY BE MADE FOR THE PURPOSE AGREED UPON. NEITHER THIS DRAWING NOR COPIES THEREOF MAY BE MADE ACCESSIBLE TO THIRD PARTIES. WITH THE DELIVERY OF THIS DRAWING NO RIGHT TO USE IT FOR ANY PURPOSE IS GRANTED. VIOLATIONS AGAINST THE OBLIGATIONS TO SECRECY AND USE RESTRICTIONS WILL BE PROSECUTED.</small>		TITLE MEGA-DRILL-STEEL-PLUS, SHANKFORM HA, COATED			FORMAT A2
 MAPAL Präzisionswerkzeuge Dr. Kress KG	DATE OF ISSUE 2022-11-13	CREATED DKO	DOCUMENT 607844194-000-00-ED1		INDEX 00
	DATE	APPROVED	MATERIAL NUMBER 30801689		ORIGIN ALD
GENERAL TOLERANCE ISO 2768-mH SIZE ISO 14405-1	DIMENSIONS NOT SHOWN ARE MAPAL STANDARDS		SCALE 2:1	TECHNICAL SPECIFICATION SCD600-0710-2-2-140HA05-HP358	
SHEET 1/1		SHEET			