



OPTIMILL-HARDENED

40.00° HELICAL FLUTET AT Ø4.00

HP810

REGRINDING INFO	
TIP	YES
OUTER DIAMETER	OPT
FLUTE	OPT
ADDING OF WORKING LENGTH	YES
ADDING OF WORKING DIAMETER	OPT
DECOATING	NO

INDEX	CHANGES	DATE	NAME

NON TOLERANCED DIMENSIONS					
0.5	> 3	> 6	> 30	> 120	> 400
...3	...6	...30	...120	...400	1000
±0.1	±0.1	±0.2	±0.3	±0.5	±0.8

RADII, CHAMFERS					
±0.2	±0.5	±1	±1	±1	±1

ANGLES, DIM. OF THE SHORTER SIDE					
bis 10	> 10	> 50	> 120	> 400	> 400
...50	...120	...400	...120	...400	...1000
±1°	±30'	±20'	±10'	±10'	±5'

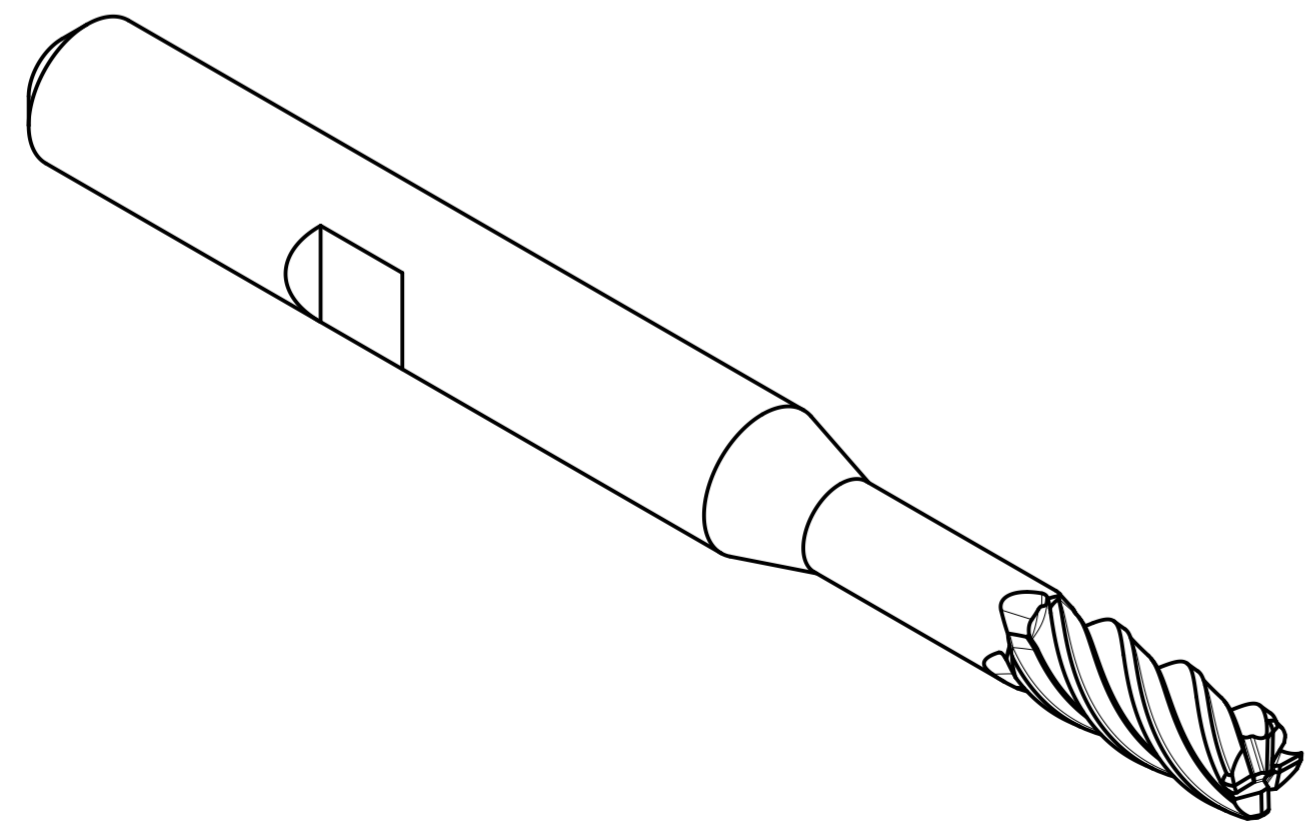
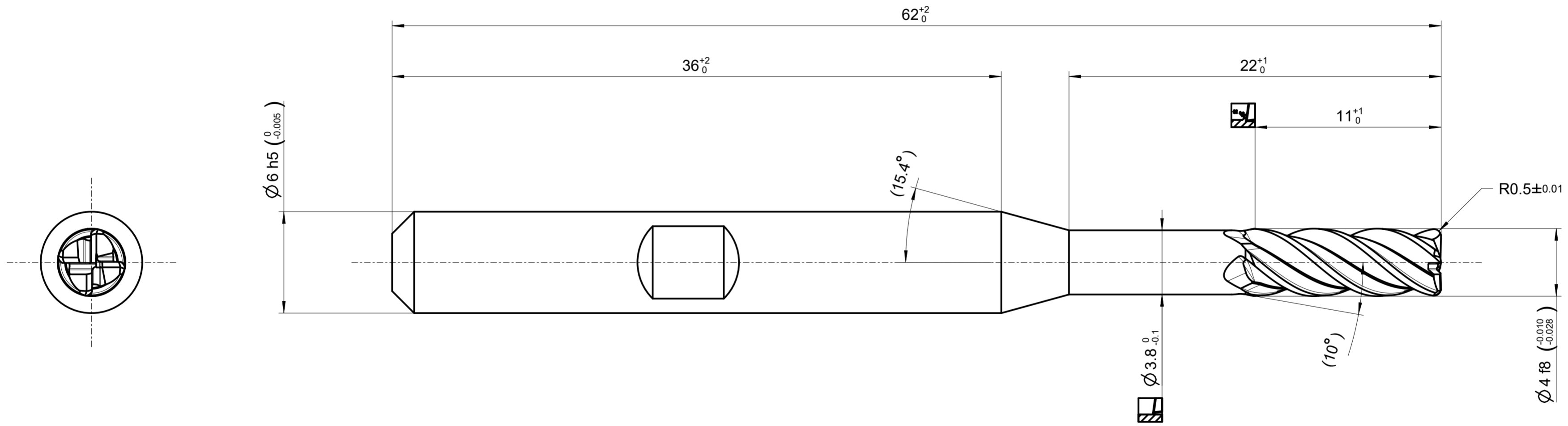

MASS
APPROX. 0.019 kg

MAPAL © FABRIK FUER PRAEZISIONSWERKZEUGE DR. KRESS KG <small>ALL RIGHTS FOR THE INVENTIONS, KNOW-HOW, TECHNICAL SOLUTIONS AND DESIGNS SHOWN ON THE DRAWING ARE ENTITLED TO MAPAL ONLY. AS FAR AS MAPAL DID NOT REGISTER PROPERTY RIGHTS HEREUPON YET, MAPAL FORMALLY RESERVES THE RIGHT FOR THE REGISTRATION OF PROPERTY RIGHTS. THE DRAWING AS WELL AS THE MATTERS SHOWN ARE STRICTLY CONFIDENTIAL. REPRODUCTIONS MAY ONLY BE MADE FOR THE PURPOSE AGREED UPON. NEITHER THIS DRAWING NOR COPIES THEREOF MAY BE MADE ACCESSIBLE TO THIRD PARTIES. WITH THE DELIVERY OF THIS DRAWING NO RIGHT TO USE IT FOR ANY PURPOSE IS GRANTED. VIOLATIONS AGAINST THE OBLIGATIONS TO SECRECY AND USE RESTRICTIONS WILL BE PROSECUTED.</small>	TITLE OPTIMILL-HARDENED, SHANKFORM HB, COATED			FORMAT A2	
	MAPAL Präzisionswerkzeuge Dr. Kress KG	DATE OF ISSUE 2024-05-10	CREATED VENU	DOCUMENT 608039963-000-00-ED1	INDEX 00
		GENERAL TOLERANCE ISO 2768-FH SIZE ISO 14405-1	DIMENSIONS NOT SHOWN ARE MAPAL STANDARDS	DATE 	APPROVED
SCALE 5:1	TECHNICAL SPECIFICATION SCM103-0400Z04R-R0050HB-HP810	SHEET 1/1			