









INDEX	CHANGES	DATE	NAME

NON TOLERANCED DIMENSIONS					
0.5	> 3	> 6	> 30	> 120	> 400
...3	...6	...30	...120	...400	...1000
± 0.1	± 0.1	± 0.2	± 0.3	± 0.5	± 0.8
RADI, CHAMFERS					
± 0.2	± 0.5	± 1	± 1	± 1	± 1
ANGLES, DIM. OF THE SHORTER SIDE					
bis 10	> 10	> 50	> 120	> 400	
...50	...120	...400			
± 1°	± 30'	± 20'	± 10'	± 5'	

-  OPTIMILL -HARDENED
-  42° HELICAL AT Ø6
-  R
-  CUT MAT HP810
-  MAT SEE CATALOG
-  WITHOUT I.C.

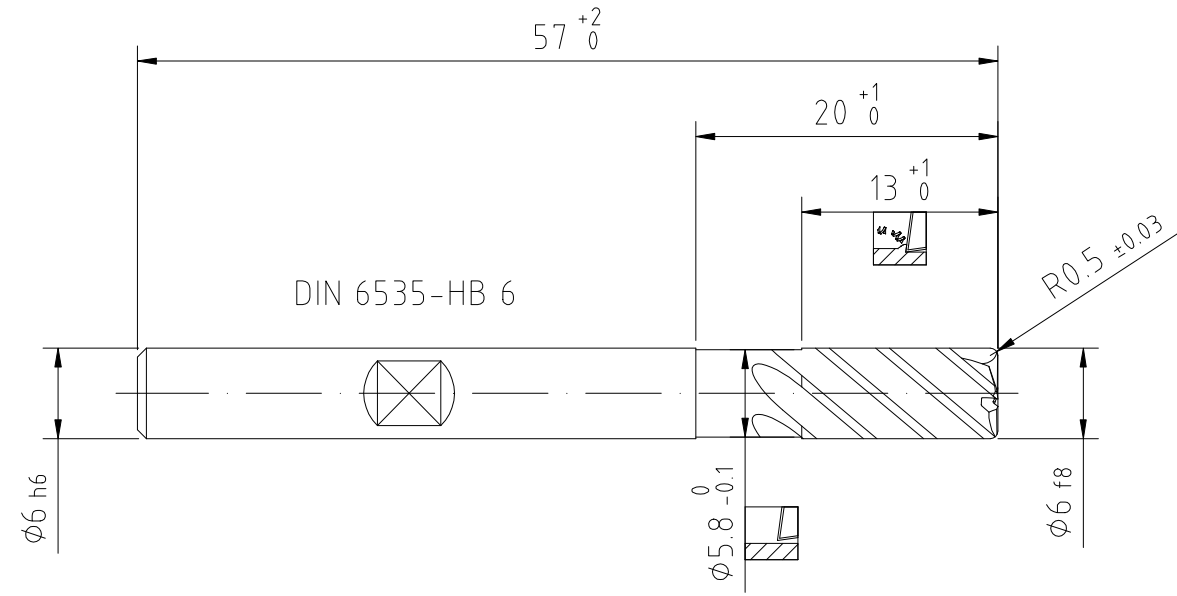
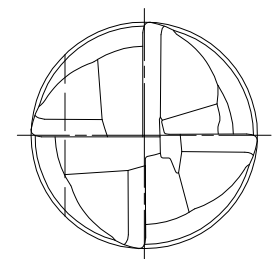
SCALE 5:1

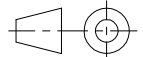

MAPAL © FABRIK FUER PRAEZISIONSWERKZEUGE DR. KRESS KG	TITLE OPTIMILL -HARDENED, SHANKFORM HB, SC, COATED			FORMAT A3	
ALL RIGHTS FOR THE INVENTIONS, KNOW-HOW, TECHNICAL SOLUTIONS AND DESIGNS SHOWN ON THE DRAWING ARE ENTITLED TO MAPAL ONLY. AS FAR AS MAPAL DID NOT REGISTER PROPERTY RIGHTS HEREUPON YET, MAPAL FORMALLY RESERVES THE RIGHT FOR THE REGISTRATION OF PROPERTY RIGHTS. THE DRAWING AS WELL AS THE MATTERS SHOWN ARE STRICTLY CONFIDENTIAL. REPRODUCTIONS MAY ONLY BE MADE FOR THE PURPOSE AGREED UPON. NEITHER THIS DRAWING NOR COPIES THEREOF MAY BE MADE ACCESSIBLE TO THIRD PARTIES. WITH THE DELIVERY OF THIS DRAWING NO RIGHT TO USE IT FOR ANY PURPOSE IS GRANTED. VIOLATIONS AGAINST THE OBLIGATIONS TO SECRECY AND USE RESTRICTIONS WILL BE PROSECUTED.	 MAPAL Präzisionswerkzeuge Dr. Kress KG	DATE OF ISSUE 2024-02-15	CREATED BST	DOCUMENT 608039831-000-00-ED1	INDEX 00
		DATE	APPROVED	MATERIAL NUMBER 31152705	ORIGIN ALD
GENERAL TOLERANCE ISO 2768-mH SIZE ISO 14405-1 Ⓢ	DIMENSIONS NOT SHOWN ARE MAPAL STANDARDS		SCALE 2:1	TECHNICAL SPECIFICATION SCM102-0600Z04R-R0050HB-HP810	SHEET 1/1