







INDEX	CHANGES	DATE	NAME

NON TOLERANCED DIMENSIONS				
0.5	> 3	> 6	> 30	> 120
...3	...6	...30	...120	...400
± 0.1	± 0.2	± 0.3	± 0.5	± 0.8
RADI, CHAMFERS				
± 0.2	± 0.5	± 1	± 1	± 1
ANGLES, DIM. OF THE SHORTER SIDE				
bis 10	> 10	> 50	> 120	> 400
...50	...120	...400		
± 1°	± 30'	± 20'	± 10'	± 5'

-  MEGA-180°-DRILL
-  30° HELICAL AT Ø 9.5
-  HP230
-  SEE TOOL CATALOG
-  WITH I.C.

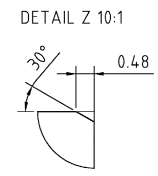
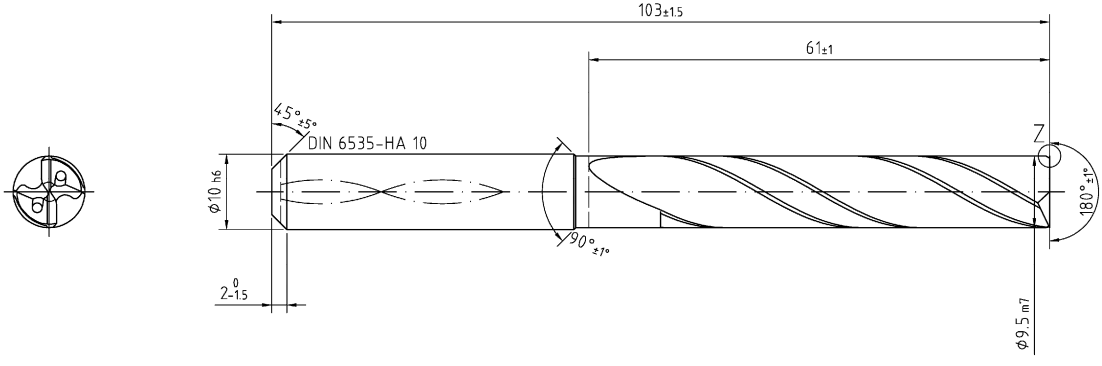

COMPONENT			MAPAL © FABRIK FUER PRAEZISIONSWERKZEUGE DR. KRESS KG			TITLE			MEGA-DRILL-180°, SHANK FORM HAK, COATED			FORMAT	
PART FEATURE			ALL RIGHTS FOR THE INVENTIONS, KNOW-HOW, TECHNICAL SOLUTIONS AND DESIGNS SHOWN ON THE DRAWING ARE INTITLED TO MAPAL ONLY, AS FAR AS MAPAL DID NOT REGISTER PROPERTY RIGHTS HEREUPON YET. MAPAL HEREBY RESERVES THE RIGHT FOR THE REGISTRATION OF PROPERTY RIGHTS. THE DRAWING AS WELL AS THE MATTERS SHOWN ARE STRICTLY CONFIDENTIAL. REPRODUCTIONS MAY ONLY BE MADE FOR THE PURPOSE AGREED UPON, NEITHER THIS DRAWING NOR COPIES THEREOF MAY BE MADE ACCESSIBLE TO THIRD PARTIES WITH THE DELIVERY OF THIS DRAWING. NO RIGHT TO USE IT FOR ANY PURPOSE IS GRANTED. VIOLATIONS AGAINST THE OBLIGATIONS TO SECRECY AND USE RESTRICTIONS WILL BE PROSECUTED.			 MAPAL Präzisionswerkzeuge Dr. Kress KG		DATE OF ISSUE	CREATED	DOCUMENT			INDEX
CUSTOMER COMPONENT REFERENCE								2022-11-23	CJ	607853517-000-00-ED1			00
WORKPIECE MATERIAL			TOOL-NO.	OP-NO.	GENERAL TOLERANCE ISO 2768-mH	DIMENSIONS NOT SHOWN	SCALE	TECHNICAL SPECIFICATION	SHEET				
SEE TOOL CATALOG					SIZE ISO 14405-1 Ⓞ	ARE MAPAL STANDARDS	2:1	SCD231-0950-2-4-180HA05-HP230	1/1				