







INDEX	CHANGES	DATE	NAME

-  TRITAN-DRILL-REAMER
-  30° HELICAL AT  $\phi$  14
-  HP358
-  SEE CATALOG
-  WITH I.C.
- 
- 

NON TOLERANCED DIMENSIONS					
0.5	> 3	> 6	> 30	> 120	> 400
...3	...6	...30	...120	...400	...1000
± 0.1	± 0.1	± 0.2	± 0.3	± 0.5	± 0.8

RADII, CHAMFERS					
± 0.2	± 0.5	± 1	± 1	± 1	± 1

ANGLES, DIM. OF THE SHORTER SIDE				
bis 10	> 10	> 50	> 120	> 400
...50	...120	...400		
± 1°	± 30'	± 20'	± 10'	± 5'

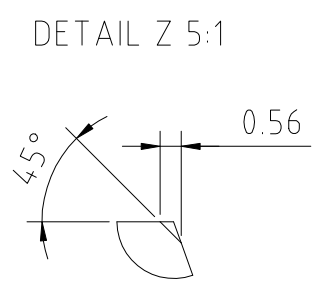
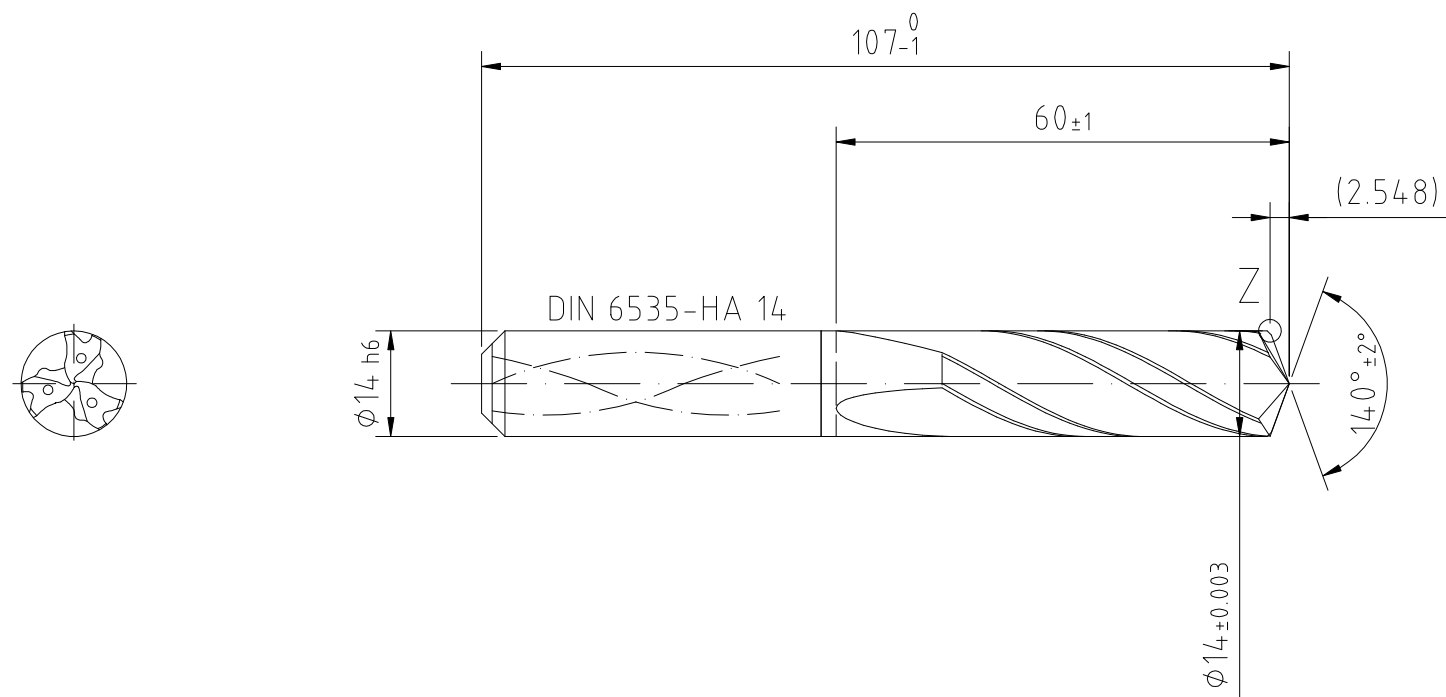

COMPONENT			MAPAL © FABRIK FUER PRAEZISIONSWERKZEUGE DR. KRESS KG		TITLE TRITAN-DRILL-REAMER, SHANKFORM HAK, COATED			FORMAT A3	
PART FEATURE			ALL RIGHTS FOR THE INVENTIONS, KNOW-HOW, TECHNICAL SOLUTIONS AND DESIGNS SHOWN ON THE DRAWING ARE ENTITLED TO MAPAL ONLY. AS FAR AS MAPAL DID NOT REGISTER PROPERTY RIGHTS HEREUPON YET, MAPAL FORMALLY RESERVES THE RIGHT FOR THE REGISTRATION OF PROPERTY RIGHTS. THE DRAWING AS WELL AS THE MATTERS SHOWN ARE STRICTLY CONFIDENTIAL. REPRODUCTIONS MAY ONLY BE MADE FOR THE PURPOSE AGREED UPON. NEITHER THIS DRAWING NOR COPIES THEREOF MAY BE MADE ACCESSIBLE TO THIRD PARTIES. WITH THE DELIVERY OF THIS DRAWING NO RIGHT TO USE IT FOR ANY PURPOSE IS GRANTED. VIOLATIONS AGAINST THE OBLIGATIONS TO SECRECY AND USE RESTRICTIONS WILL BE PROSECUTED.		 <b>MAPAL</b> <b>Präzisionswerkzeuge</b> <b>Dr. Kress KG</b>	DATE OF ISSUE 2022-03-02	CREATED ASP	DOCUMENT 607685308-000-00-ED1	INDEX 00
CUSTOMER COMPONENT REFERENCE						DATE	APPROVED	MATERIAL NUMBER 31196563	ORIGIN ALD
WORKPIECE MATERIAL	TOOL-NO.	OP-NO.	GENERAL TOLERANCE ISO 2768-mH SIZE ISO 14405-1 Ⓢ		DIMENSIONS NOT SHOWN ARE MAPAL STANDARDS		SCALE 1:1	TECHNICAL SPECIFICATION SCD641C-1400-3-6-140HA03-HP358	SHEET 1/1