

INDEX	CHANGES	DATE	NAME







NON TOLERANCED DIMENSIONS					
0.5	> 3	> 6	> 30	> 120	> 400
...3	...6	...30	...120	...400	...1000
± 0.1	± 0.1	± 0.2	± 0.3	± 0.5	± 0.8

  

RADIOI, CHAMFERS					
± 0.2	± 0.5	± 1	± 1	± 1	± 1

ANGLES, DIM. OF THE SHORTER SIDE				
bis 10	> 10	> 50	> 120	> 400
...50	...50	...120	...400	...400
± 1°	± 30'	± 20'	± 10'	± 5'

-  TRITAN-DRILL-REAMER
-  30° HELICAL AT  $\phi$  16.01
-  R
-  HP358
-  MAT SEE TOOL CATALOG
-  WITH I.C.

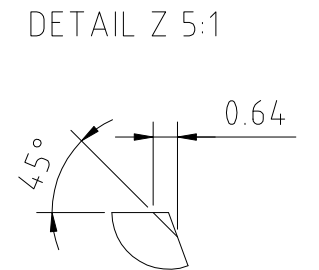
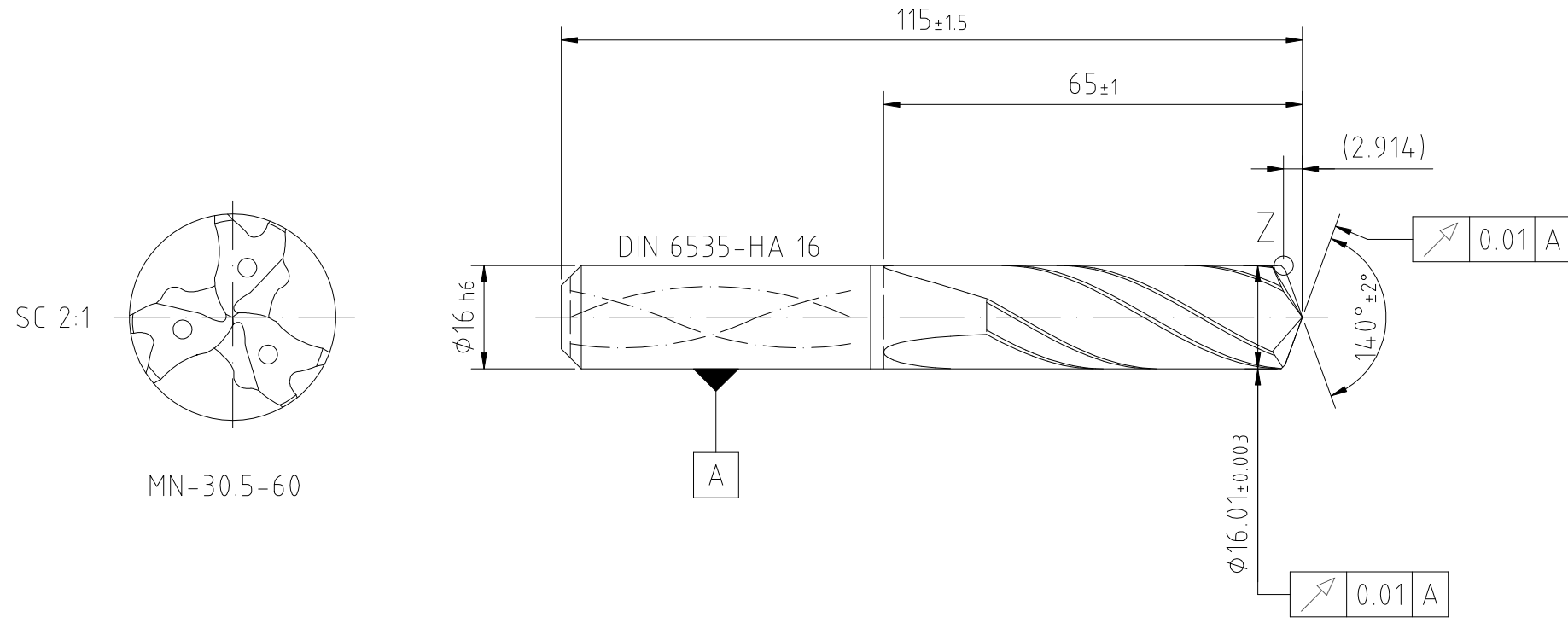

PART	TYP	QUANT.	UT	MATERIAL NUMBER	DESCRIPTION	TECHNICAL SPECIFICATION	CUSTOMER MATERIAL NUMBER
1		1	PC	31198374	CARBIDE ROUND BAR	1630R120L150-0950-08700-CTS20D	

MAPAL © FABRIK FUER PRAEZISIONSWERKZEUGE DR. KRESS KG				TITLE TRITAN-DRILL-REAMER, SHANKFORM HAK, COATED				FORMAT A3	
<small>ALL RIGHTS FOR THE INVENTIONS, KNOW-HOW, TECHNICAL SOLUTIONS AND DESIGNS SHOWN ON THE DRAWING ARE ENTITLED TO MAPAL ONLY. AS FAR AS MAPAL DID NOT REGISTER PROPERTY RIGHTS HEREUPON YET, MAPAL FORMALLY RESERVES THE RIGHT FOR THE REGISTRATION OF PROPERTY RIGHTS. THE DRAWING AS WELL AS THE MATTERS SHOWN ARE STRICTLY CONFIDENTIAL. REPRODUCTIONS MAY ONLY BE MADE FOR THE PURPOSE AGREED UPON. NEITHER THIS DRAWING NOR COPIES THEREOF MAY BE MADE ACCESSIBLE TO THIRD PARTIES. WITH THE DELIVERY OF THIS DRAWING NO RIGHT TO USE IT FOR ANY PURPOSE IS GRANTED. VIOLATIONS AGAINST THE OBLIGATIONS TO SECRECY AND USE RESTRICTIONS WILL BE PROSECUTED.</small>				 <b>MAPAL</b> Präzisionswerkzeuge Dr. Kress KG		DATE OF ISSUE 2024-06-19	CREATED CJ	DOCUMENT 608104525-000-00-ED1	INDEX 00
						DATE	APPROVED	MATERIAL NUMBER 31196613	ORIGIN ALD
GENERAL TOLERANCE ISO 2768-mH SIZE ISO 14405-1 ©				DIMENSIONS NOT SHOWN ARE MAPAL STANDARDS		 SCALE 1:1	TECHNICAL SPECIFICATION SDR301G-16.010+3-3-HA03-HP358	SHEET 1/1	