

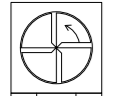

INDEX	CHANGES	DATE	NAME



NON TOLERANCED DIMENSIONS				
0.5	> 3	> 6	> 30	> 120
... 3	... 6	... 30	... 120	... 400
± 0.1	± 0.1	± 0.2	± 0.3	± 0.5
± 0.8	± 0.8	± 0.8	± 0.8	± 0.8
RADII, CHAMFERS				
± 0.2	± 0.5	± 1	± 1	± 1
ANGLES, DIM. OF THE SHORTER SIDE				
bis 10	> 10	> 50	> 120	> 400
... 50	... 120	... 400	... 400	... 400
± 1°	± 30'	± 20'	± 10'	± 5'

 OPTIMILL-3D-CR,Z=4
 HP803

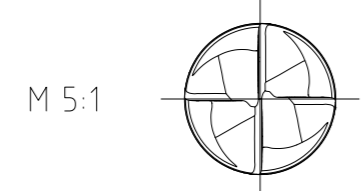
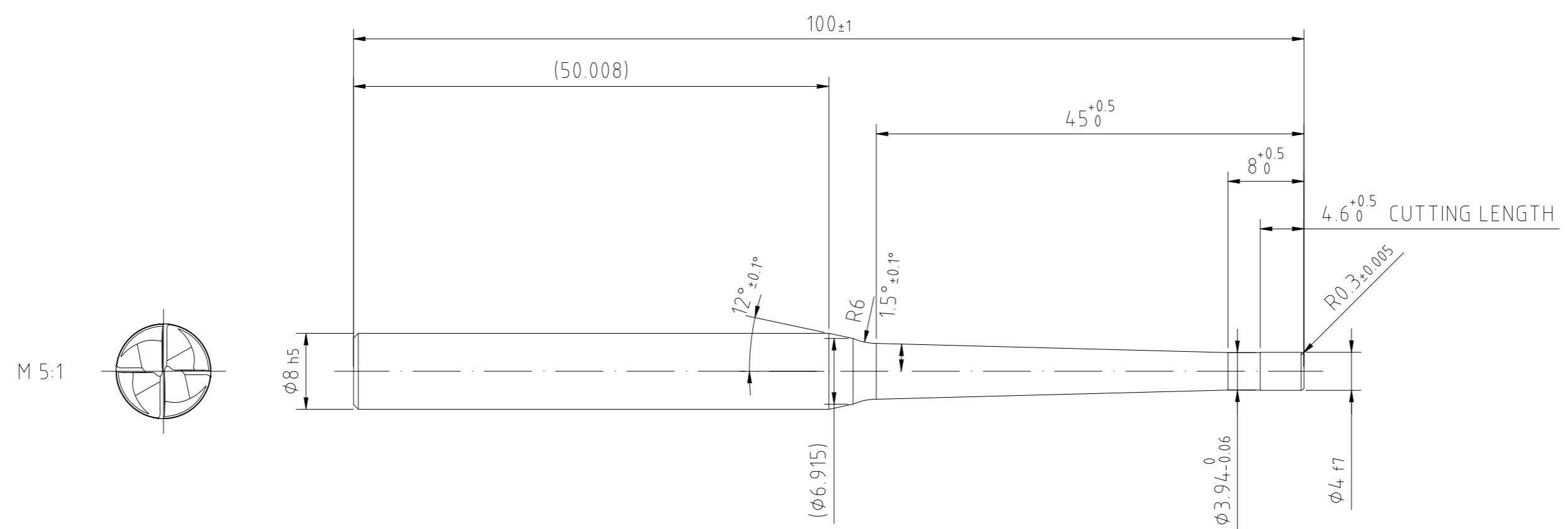

REGRINDING INFO	
TIP	<input type="radio"/>
OUTER DIAMETER	<input type="radio"/>
FLUTE	<input type="radio"/>
ADDING OF WORKING LENGTH	<input type="radio"/>
ADDING OF WORKING DIAMETER	<input type="radio"/>
DECOATING	<input type="radio"/>

YES OPTIONAL NO

MAPAL © FABRIK FUER PRAEZISIONSWERKZEUGE DR. KRESS KG <small>ALL RIGHTS FOR THE INVENTIONS, KNOW-HOW, TECHNICAL SOLUTIONS AND DESIGNS SHOWN ON THE DRAWING ARE ENTITLED TO MAPAL ONLY. AS FAR AS MAPAL DID NOT REGISTER PROPERTY RIGHTS HEREUPON YET, MAPAL FORMALLY RESERVES THE RIGHT FOR THE REGISTRATION OF PROPERTY RIGHTS. THE DRAWING AS WELL AS THE MATTERS SHOWN ARE STRICTLY CONFIDENTIAL. REPRODUCTIONS MAY ONLY BE MADE FOR THE PURPOSE AGREED UPON. NEITHER THIS DRAWING NOR COPIES THEREOF MAY BE MADE ACCESSIBLE TO THIRD PARTIES. WITH THE DELIVERY OF THIS DRAWING NO RIGHT TO USE IT FOR ANY PURPOSE IS GRANTED. VIOLATIONS AGAINST THE OBLIGATIONS TO SECRECY AND USE RESTRICTIONS WILL BE PROSECUTED.</small>	TITLE  MAPAL Präzisionswerkzeuge Dr. Kress KG	DATE OF ISSUE 2021-11-25	CREATED MF	DOCUMENT 6074.08593-000-01-ED1	INDEX 00
GENERAL TOLERANCE ISO 2768-mH SIZE ISO 14.405-1	DIMENSIONS NOT SHOWN ARE MAPAL STANDARDS	DATE 	APPROVED 	MATERIAL NUMBER 31154408	ORIGIN AAD
SCALE 2:1	TECHNICAL SPECIFICATION	SHEET 1/1	FORMAT A2	INDEX 00	ORIGIN AAD