









1 2 3 4 5 6 7 8 9 10 11 12

INDEX	CHANGES	DATE	NAME

NON TOLERANCED DIMENSIONS				
0.5	> 3	> 6	> 30	> 120 > 400
...3	...6	...30	...120	...400
± 0.1	± 0.1	± 0.2	± 0.3	± 0.5 ± 0.8
RADII, CHAMFERS				
± 0.2	± 0.5	± 1	± 1	± 1
ANGLES, DIM. OF THE SHORTER SIDE				
bis 10	> 10	> 50	> 120	> 400
...50	...120	...400		
± 1°	± 30'	± 20'	± 10'	± 5'

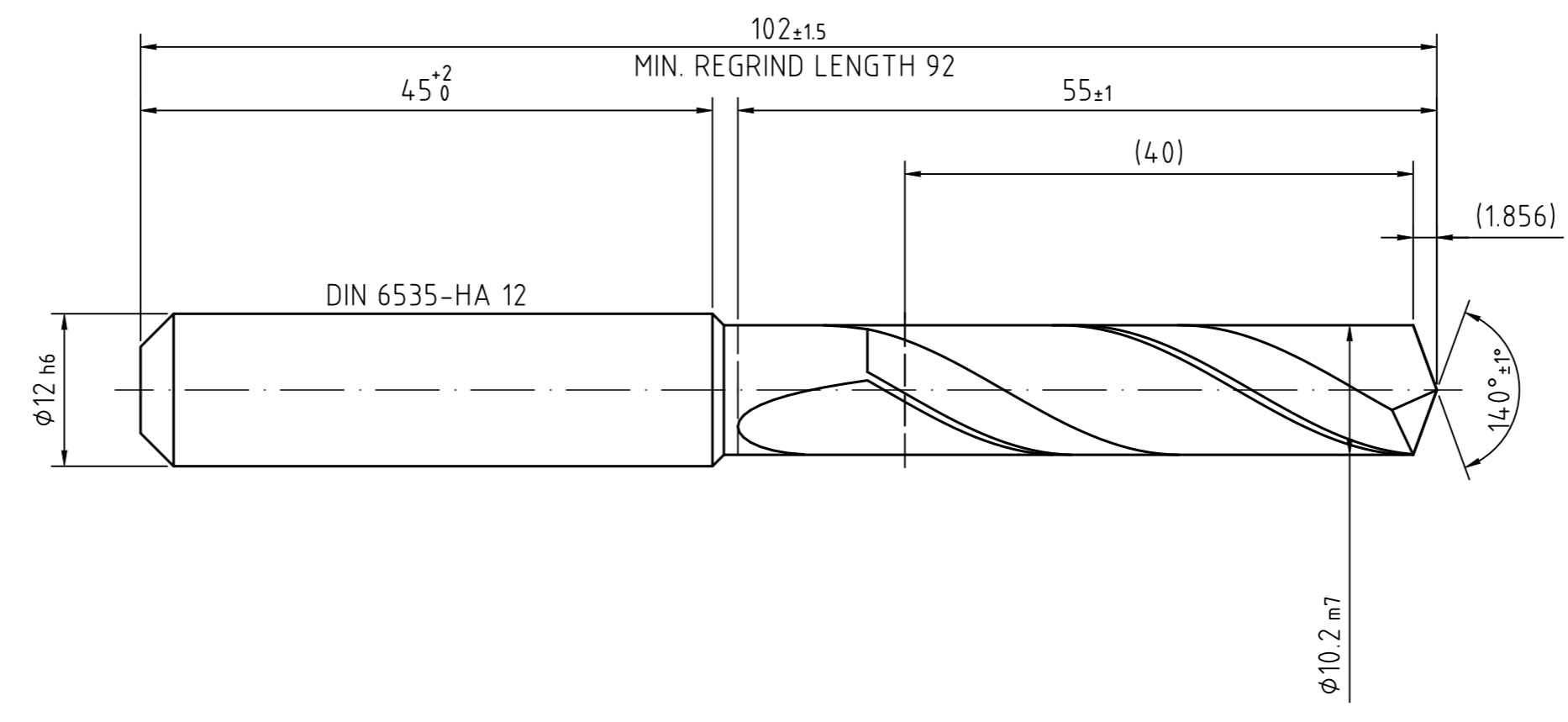
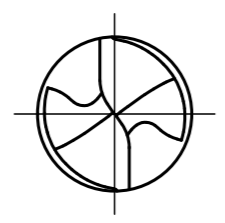
-  MEGA-DRILL-STEEL-PLUS
-  30° HELICAL
-  HP358
-  WITHOUT I.C.
- 
- 



<b>MAPAL ©</b> FABRIK FUER PRAEZISIONSWERKZEUGE DR. KRESS KG <small>ALL RIGHTS FOR THE INVENTIONS, KNOW-HOW, TECHNICAL SOLUTIONS AND DESIGNS SHOWN ON THE DRAWING ARE ENTITLED TO MAPAL ONLY. AS FAR AS MAPAL DID NOT REGISTER PROPERTY RIGHTS HEREUPON YET, MAPAL FORMALLY RESERVES THE RIGHT FOR THE REGISTRATION OF PROPERTY RIGHTS. THE DRAWING AS WELL AS THE MATTERS SHOWN ARE STRICTLY CONFIDENTIAL. REPRODUCTIONS MAY ONLY BE MADE FOR THE PURPOSE AGREED UPON. NEITHER THIS DRAWING NOR COPIES THEREOF MAY BE MADE ACCESSIBLE TO THIRD PARTIES. WITH THE DELIVERY OF THIS DRAWING NO RIGHT TO USE IT FOR ANY PURPOSE IS GRANTED. VIOLATIONS AGAINST THE OBLIGATIONS TO SECRECY AND USE RESTRICTIONS WILL BE PROSECUTED.</small>		<b>TITLE</b> MEGA-DRILL-STEEL-PLUS, SHANKFORM HA, COATED			<b>FORMAT</b> A2
 <b>MAPAL</b> Präzisionswerkzeuge Dr. Kress KG	<b>DATE OF ISSUE</b> 2022-11-11	<b>CREATED</b> DKO	<b>DOCUMENT</b> 607842584-000-00-ED1		<b>INDEX</b> 00
	<b>DATE</b>	<b>APPROVED</b>	<b>MATERIAL NUMBER</b> 30801219		<b>ORIGIN</b> ALD
<b>GENERAL TOLERANCE</b> ISO 2768-mH SIZE ISO 14405-1	<b>DIMENSIONS NOT SHOWN</b> ARE MAPAL STANDARDS		<b>SCALE</b> 2:1	<b>TECHNICAL SPECIFICATION</b> SCD600-1020-2-2-140HA03-HP358	
<b>SHEET</b> 1/1				<b>SHEET</b> 1/1	

1 2 3 4 5 6 7 8 9 10 11 12