







1	2	3	4	5	6	7	8		
A						INDEX	CHANGES	DATE	NAME
B									
C									
D									
E									
F									

-  OPTIMILL-UNI-WAVE
-  35° HELICAL AT $\phi 12$
-  HP723
-  SEE CATALOG
-  WITHOUT I.C.

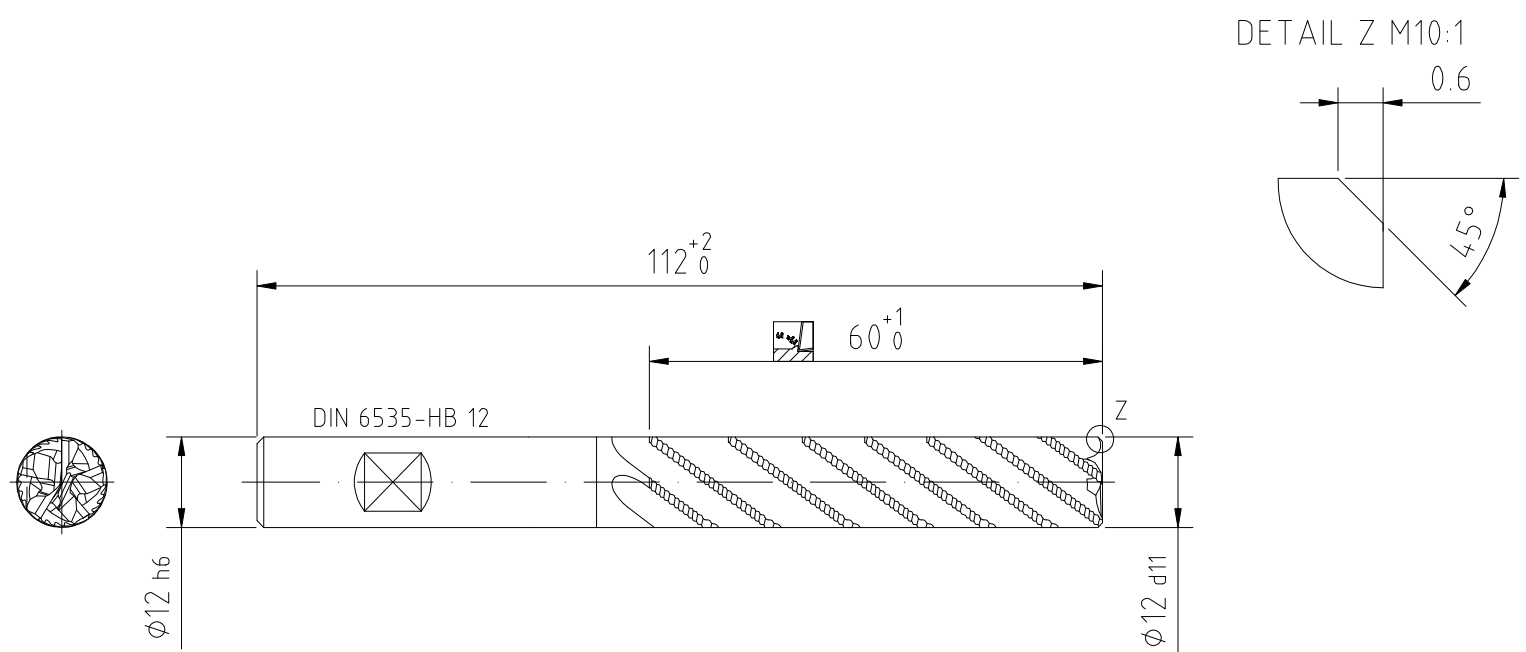
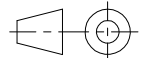

MAPAL © FABRIK FUER PRAEZISIONSWERKZEUGE DR. KRESS KG <small>ALL RIGHTS FOR THE INVENTIONS, KNOW-HOW, TECHNICAL SOLUTIONS AND DESIGNS SHOWN ON THE DRAWING ARE ENTITLED TO MAPAL ONLY. AS FAR AS MAPAL DID NOT REGISTER PROPERTY RIGHTS HEREUPON YET, MAPAL FORMALLY RESERVES THE RIGHT FOR THE REGISTRATION OF PROPERTY RIGHTS. THE DRAWING AS WELL AS THE MATTERS SHOWN ARE STRICTLY CONFIDENTIAL. REPRODUCTIONS MAY ONLY BE MADE FOR THE PURPOSE AGREED UPON. NEITHER THIS DRAWING NOR COPIES THEREOF MAY BE MADE ACCESSIBLE TO THIRD PARTIES. WITH THE DELIVERY OF THIS DRAWING NO RIGHT TO USE IT FOR ANY PURPOSE IS GRANTED. VIOLATIONS AGAINST THE OBLIGATIONS TO SECRECY AND USE RESTRICTIONS WILL BE PROSECUTED.</small>	TITLE OPTIMILL-UNI-WAVE, SC, COATED				DATE OF ISSUE 2023-02-24	CREATED HEINRICH	DOCUMENT 607911627-000-00-ED1	INDEX 00
	 MAPAL Präzisionswerkzeuge Dr. Kress KG		DATE	APPROVED	MATERIAL NUMBER 31240671	ORIGIN ALD		
	GENERAL TOLERANCE ISO 2768-mH SIZE ISO 14405-1 ©	DIMENSIONS NOT SHOWN ARE MAPAL STANDARDS		SCALE 1:1	TECHNICAL SPECIFICATION SCM900-1200Z05R-F0060HB5-HP723	SHEET 1/1		